



## Commercial Products

### Suggested List Price Schedule

Effective January 1, 2017

The Suggested List Price Schedule is intended only as a guideline to pricing. It does not restrict the price a distributor or dealer may establish.

Our global-leading ice products and services are very local. To see how easy it is to bring them to your location, call 1-800-SCOTSMAN (726-8762) or visit [www.scotsman-ice.com](http://www.scotsman-ice.com).



Scan to learn more.

# Scotsman®



## Why Scotsman?



### Certified Product Performance

So you don't have to just take our word for it, AHRI provides Scotsman with certifications for almost every single one of our ice machines and bins. AHRI is the trusted source of performance certified heating, ventilation, air-conditioning and commercial refrigeration equipment and components.

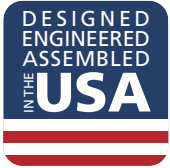

Our goal is to deliver superior performance every day, from our award-winning, U.S.-based manufacturing and high-quality materials to user-friendly functionality and world-class service and support. It's ice on a whole new level - and it's how Scotsman is helping today's operators do more.



### Dedicated Global Sales & Service Network

Provides product availability and maintenance locally, when and where you need it. For technical assistance, call 1-800-533-6006.



## A TRADITION OF REAL INNOVATION

From the introduction of Nugget Ice – The Original Chewable Ice® – to our newest self-monitoring Prodigy Plus® ice systems that produce the most ice with one of the market's smallest available footprints, Scotsman has a strong record of innovation.



## A COMMITMENT TO SMART MANUFACTURING

At Scotsman, our quality story begins inside our award-winning production facility in South Carolina. And with 99% of our equipment U.S.-based, we're proud to keep things close to home.



## AN INTUITIVE SENSE OF CONTROL

When equipment is functioning smoothly, operators have more time and energy to spend on serving customers. That's why Scotsman offers an impressive array of technology that keeps operators informed – well before issues arise.



## A FOCUS ON EFFICIENCY AND SAVINGS

Our team works continuously on cost-saving innovations and efficiency improvements, ensuring the highest quality, reliability and profitability.

# An Ice Form to Meet Every Need!



## SMALL & MEDIUM CUBE ICE

Our familiar crystal-clear diced ice cube form.

**APPLICATIONS:** Mixed Drinks  
Carbonated Beverages  
Ice Dispensing  
Banquet Services

**SIZE:** Small: 7/8" x 7/8" x 3/8"  
Medium: 7/8" x 7/8" x 7/8"

**ADVANTAGES:** Available in both small and medium sizes to fit your needs. For optimum liquid displacement, choose the small cube size.



## NUGGET ICE

Soft, cylindrical and slow-melting, our proprietary nugget ice is The Original Chewable Ice® - a customer favorite for decades. H<sup>2</sup> Nugget available for Meridian™ Series only.

**APPLICATIONS:** Carbonated Beverages  
Food Displays  
Ice Dispensing  
Therapeutic Applications

**SIZE:** 3/4" x 5/16" x 3/8"

**ADVANTAGES:** Scotsman Nugget Ice® is our most versatile form. Each individual piece remains free-flowing at all times while helping drinks cool rapidly and maintain their flavor.



## FLAKE ICE

These small pieces of ice combine fast cooling power with very low production costs.

**APPLICATIONS:** Blended Cocktails  
Salad Bars  
Meat & Seafood Displays  
Banquet Services

**SIZE:** Compressed Flake Ice

**ADVANTAGES:** These small pieces of ice combine fast cooling power with very low production costs. Flakes mold to any shape for convenient use in displays and salad bars.



## GOURMET ICE

The perfect unique shape for upscale bars and restaurants.

**APPLICATIONS:** Bar Use  
Waitress Stations  
Office Suites  
Break Rooms

**SIZE:** 1" x 1 1/8" x 1 1/4"

**ADVANTAGES:** The size and longevity of our gourmet cubes make them the perfect choice for re-icing glasses while their non-stick quality and slow-melting design make scooping easier than ever.



## Guidelines to Sizing Ice Systems:

Every operation is different and requires special considerations in sizing equipment. For new locations, use the guidelines below. You may want to add 10-20% for growth or add for unusual types of usage i.e. icing down drink barrels, bagging ice for resale. For a replacement unit, be sure to ask if the existing unit met the operator's needs. If not, add the amount of ice being purchased to the capacity of the existing unit to determine necessary production for the new unit.

### Food Service

#### Restaurants:

1.7 lb (0.8 kg) per customer or 5.0 lb (2.3 kg) per seat.

#### Cocktail Lounge:

3 lb (1.4 kg) per customer.

#### Salad Bar:

Add 35 lb (15.9 kg) per cubic foot of display. Multiply by 2 or 3 depending on estimated refills required.

#### Fast Food:

0.9 lb (0.4 kg) per customer or 7.4 lb per seat. Use 2 oz per 8-10 oz drink; 4 oz per 12-16 oz drink.

### Convenience Stores/Customer Self-Service

4 oz per 12 oz drink; 7 oz per 20 oz drink; 10 oz per 32 oz drink. Cold plate-add 50% more.

### Health Care:

8 lb (3.6 kg) per patient bed. Use 3 lb (1.4 kg) per employee.

### Lodging:

3 lb (1.4 kg) per guest room. Plan on substantially more if guests are allowed to fill ice chests.



## Energy Star Certified

## We're Out to Ensure the World Stays a Colder Place.



2013 & 2012 ENERGY STAR® Partner of the Year Award

2011 ENERGY STAR® Award for Excellence in Energy-Efficient Product Design

Offering more than 35 ENERGY STAR certified models, Scotsman Prodigy ice machines incorporate superior designs that reduce energy and water consumption, making a difference for the environment and the bottom line.



Just look for the  symbol throughout the price book to find our Energy Star® qualified products.





# Prodigy Plus® Modular Cubers Utilizing AquaArmor™ with AgION®

\*Refer to page 18 & 20 for required bin tops.



Unit Dimensions (W x D x H)	Cube Size	Model Number	Condenser Type	24 hr Ice Production		Shipping Weight lb/kg	List Price Volts/Hz/Phase			
				70°F/21°C 50°F/10°C lb/kg	Air Water		90°F/32°C 70°F/21°C lb/kg	115/60/1 -1	208-230/60/1 -32	230/50/1 -6
 22" x 24" x 23" 55.9 x 61.0 x 58.4 cm	Med. Sm.	<b>C0322</b>	Air Water Air Water	356/162 366/166 356/162 366/166	Air Water	233/106 292/133 233/106 292/133	145/66 145/66 145/66 145/66	\$5,452 ✓	\$5,527 ✓	\$5,577 ●
		C0322MA						\$5,452		\$5,577 ●
		C0322MW						\$5,452		\$5,577 ●
		C0322SA						\$5,452		\$5,577 ●
	C0322SW	\$5,452		\$5,577 ●						
	Med. Sm.	<b>C0522</b>	Air Water Air Water	475/216 480/218 475/216 480/218	Air Water	340/155 409/186 340/155 409/186	160/73 160/73 160/73 160/73	\$5,729	\$5,804	\$5,854 ●
		C0522MA						\$5,729		\$5,854 ●
		C0522MW						\$5,729		\$5,854 ●
C0522SA		\$5,729							\$5,854 ●	
C0522SW	\$5,729		\$5,854 ●							
 22" x 24" x 29" 55.9 x 61.0 x 73.7 cm	Med. Sm.	<b>C0722</b>	Air Air	758/345 758/345	Air	566/257 566/257	180/82 180/82		\$7,025	\$7,150 ●
		C0722MA							\$7,025	\$7,150 ●
		C0722SA							\$7,025	\$7,150 ●

Unit Dimensions (W x D x H)	Cube Size	Model Number	Condenser Type	24 hr Ice Production		Shipping Weight lb/kg	List Price Volts/Hz/Phase			
				70°F/21°C 50°F/10°C lb/kg	Air Water		90°F/32°C 70°F/21°C lb/kg	115/60/1 -1	208-230/60/1 -32	230/50/1 -6
 30" x 24" x 23" 76.2 x 61.0 x 58.4 cm	Med. Sm.	<b>C0330</b>	Air Water Air Water	400/182 420/191 400/182 420/191	Air Water	288/131 300/136 288/131 300/136	160/73 160/73 160/73 160/73	\$5,255 ✓	\$5,330 ✓	
		C0330MA						\$5,255		
		C0330MW						\$5,255		
		C0330SA						\$5,255		
	C0330SW	\$5,255								
	Med. Sm.	<b>C0530</b>	Air Remote Water Air Remote Water	525/238 500/227 500/227 525/238 500/227 500/227	Air Remote Water	380/172 400/181 410/186 380/172 400/181 410/186	175/80 175/80 175/80 175/80 175/80 175/80	\$5,824 ✓	\$5,899 ✓	\$5,949 ●
		C0530MA						\$5,824		\$5,949 ●
		C0530MR						\$5,724		
		C0530MW						\$5,824		
		C0530SA						\$5,824		\$5,949 ●
C0530SR		\$5,724								
C0530SW	\$5,824									

Unit Dimensions (W x D x H)	Cube Size	Model Number	Condenser Type	24 hr Ice Production		Shipping Weight lb/kg	List Price Volts/Hz/Phase			
				70°F/21°C 50°F/10°C lb/kg	Air Water		90°F/32°C 70°F/21°C lb/kg	208-230/60/1 -32	208-230/60/3 N/A	230/50/1 -6
 30" x 24" x 23" 76.2 x 61.0 x 58.4 cm	Med. Sm.	<b>C0630</b>	Air Remote Water Air Remote Water	640/291 614/279 633/288 640/291 614/279 633/288	Air Remote Water	474/215 540/245 573/260 474/215 540/245 573/260	190/86 190/86 190/86 190/86 190/86 190/86	\$7,018		\$7,143 ●
		C0630MA						\$6,918		
		C0630MR						\$7,018		
		C0630MW						\$7,018		
		C0630SA						\$7,018		\$7,143 ●
		C0630SR						\$6,918		
		C0630SW						\$7,018		

4. ✓ = Energy Star certified. ● = CE Approved.  
 Combine model number and electrical indicator when ordering for exact SKU, i.e. C0322MA-1. See page 16 for storage bins.

# Prodigy Plus® Modular Cubers Utilizing AquaArmor™ with AgION®

Unit Dimensions (W x D x H)	Cube Size	Model Number	Condenser Type	24 hr Ice Production		Shipping Weight lb/kg	List Price Volts/Hz/Phase			
				70°F/21°C 50°F/10°C lb/kg	Air Water		90°F/32°C 70°F/21°C lb/kg	208-230/60/1 -32	208-230/60/3 -3	230/50/1 -6
 30" x 24" x 29" 76.2 x 61.0 x 73.7 cm	Med.	<b>C0830</b>		Air	905/411	718/326	220/100	\$8,924 ✓	\$9,099 ✓	\$9,149 ●
		C0830MR	Remote	870/395	780/355	220/100	\$8,824 ✓			
		C0830MW	Water	924/420	832/378	220/100	\$8,924			
		Sm.	C0830SA	Air	905/411	718/326	220/100	\$8,924 ✓	\$9,099 ✓	\$9,149 ●
			C0830SR	Remote	870/395	780/355	220/100	\$8,824 ✓		
			C0830SW	Water	924/420	832/378	220/100	\$8,924		
	Med.	<b>C1030</b>		Air	1077/490	789/359	235/107	\$10,165 ✓		\$10,390 ●
		C1030MR	Remote	996/453	820/373	235/107	\$10,065 ✓	\$10,240		
		C1030MW	Water	996/453	908/413	235/107	\$10,165			
		Sm.	C1030SA	Air	1077/490	789/359	235/107	\$10,165 ✓		\$10,390 ●
			C1030SR	Remote	996/453	820/373	235/107	\$10,065 ✓	\$10,240 ✓	\$10,290 ●
			C1030SW	Water	996/453	908/413	235/107	\$10,165		

Unit Dimensions (W x D x H)	Cube Size	Model Number	Condenser Type	24 hr Ice Production		Shipping Weight lb/kg	List Price Volts/Hz/Phase			
				70°F/21°C 50°F/10°C lb/kg	Air Water		90°F/32°C 70°F/21°C lb/kg	208-230/60/1 -32	208-230/60/3 -3	230/50/1 -6
 48" x 24" x 29" 121.9 x 61.0 x 73.7 cm	Med.	<b>C1448</b>		Air	1553/706	1296/589	345/157	\$11,525	\$11,700	\$11,750 ●
		C1448MR	Remote	1357/617	1258/572	345/157	\$11,425 ✓	\$11,600		
		C1448MW	Water	1444/656	1340/609	345/157	\$11,525	\$11,700		
		Sm.	C1448SA	Air	1553/706	1296/589	345/157	\$11,525	\$11,700	\$11,750 ●
			C1448SR	Remote	1357/617	1258/572	345/157	\$11,425 ✓	\$11,600	
			C1448SW	Water	1444/656	1340/609	345/157	\$11,525	\$11,700	
	Med.	<b>C1848</b>		Air	1909/868	1527/694	355/161	\$15,171		\$15,396 ●
		C1848MR	Remote	1828/831	1645/748	355/161	\$15,071 ✓	\$15,246	\$15,296	
		C1848MW	Water	1900/864	1710/777	355/161	\$15,171			
		Sm.	C1848SA	Air	1909/868	1527/694	355/161	\$15,171		\$15,396 ●
			C1848SR	Remote	1828/831	1645/748	355/161	\$15,071 ✓	\$15,246 ✓	\$15,296 ●
			C1848SW	Water	1900/864	1710/777	355/161	\$15,171		
	Med.	<b>C2148</b>		Remote	2248/1022	1849/840	370/168	\$18,469	\$18,644	\$18,694 ●
		C2148SR	Remote	2248/1022	1849/840	370/168	\$18,469	\$18,644	\$18,694 ●	

Unit Dimensions (W x D x H)	Cube Size	Model Number	Condenser Type	24 hr Ice Production		Shipping Weight lb/kg	List Price Volts/Hz/Phase			
				70°F/21°C 50°F/10°C lb/kg	Air Water		90°F/32°C 70°F/21°C lb/kg	208-230/60/1 N/A	208-230/60/3 -3	230/50/1 N/A
 48" x 28.5" x 34" 121.9 x 72.39 x 86.36 cm	Med. Sm.	<b>C2648</b>		Remote	2630/1193	2256/1023	430/195		\$19,580 ✓	
		C2648MR	Remote	2630/1193	2256/1023	430/195		\$19,580		
		C2648SR	Remote	2630/1193	2224/1009	430/195				

# Modular Cuber Kits and Accessories

Unit Dimensions (W x D x H)	Model Number	Description	Shipping Weight lb/kg	List Price Volts/Hz/Phase		
				115/60/1 -1	208-230/60/1 -32	230/50/1 -6
22" x 24" x 23" 55.9 x 61.0 x 58.4 cm	<b>Remote Condensers</b> ERC111	Remote condenser for C0522xR or C0530xR	95/43	\$1,828		
22" x 24" x 23" 55.9 x 61.0 x 58.4 cm	ERC311	Remote condenser for C0630xR, C0830xR, C1030xR, or C1448xR	130/59		\$1,929	\$2,054
22" x 24" x 23" 55.9 x 61.0 x 58.4 cm	ERC611	Remote condenser for C1848xR or C2148xR	140/84		\$2,790	
22" x 24" x 29" 55.9 x 61.0 x 73.7 cm	PRC241	Remote condenser for C2648xR	135/61		\$3,247	

Model Number	Description	Shipping Weight lb/kg	List Price
<b>Miscellaneous</b>			
KERCF	Air filter for ERC111 or ERC311	5/2	\$135
RCKCME6GX	Remote condensing kit for connecting all Prodigy® models to non-Scotsman remote condenser coils	25/11	\$526
KTPS-SM	Tamper Proof Screw Kit (incl. Tool) to convert 22" (55.9 cm), 30" (76.2 cm) or 48" (121.9 cm) cuber	5/2	\$181
<b>Line Sets</b>			
RTE10	10 ft (3m) precharged R-404A tubing	7/3	\$364
RTE25	25 ft (7.6m) precharged R-404A tubing	12/6	\$506
RTE40	40 ft (12.2m) precharged R-404A tubing	17/8	\$557
RTE75	75 ft (22.9m) precharged R-404A tubing	35/16	\$807
KTE4	Tube end kit - contains 4 quick connect fittings for any RTE Line Set	5/2	\$185
RTEL25	25 ft (7.6m) precharged R-404A tubing. Use with C2648 remote cooled units	16/7	\$449
RTEL40	40 ft (12.2m) precharged R-404A tubing. Use with C2648 remote cooled units	22/10	\$622
RTEL75	75 ft (22.9m) precharged R-404A tubing. Use with C2648 remote cooled units	40/18	\$873
KTEL4	Tube end kit - contains 4 quick connect fittings for any RTEL Line Set	5/2	\$217
<b>Prodigy® Modular Cuber Accessories</b>			
KPAS	Kit - Prodigy Advanced Sustainability. Includes KSBU-N and KVS	10/4	\$1,022
KSBU	Kit - Prodigy Smart-Board™ - Use additional operational data for fast diagnosis	5/2	\$687
KSBU-N	Kit - Prodigy Smart-Board™ - Network connection	5/2	\$898
KVS	Kit - Prodigy Vari-Smart™ Ice Level Control - Adjust ice levels to match ice needs	5/2	\$308
<b>Air Flow Kits</b>			
KPPSA223	Kit - Prodigy Plus® Side Air Flow for C0322, C0522, N0422, F0522, N0622, F0822	11/5	\$270
KPPSA229	Kit - Prodigy Plus® Side Air Flow for C0722	13/6	\$330
KPPSA323	Kit - Prodigy Plus® Side Air Flow for C0330, C0530, C0630	13/6	\$296
KPPSA329	Kit - Prodigy Plus® Side Air Flow for C0830, C1030	15/7	\$350
KPMFA223-B	Kit - Prodigy® Front Air Flow for C0322, C0522 (B revisions only)	11/5	\$215
KPMFA303-B	Kit - Prodigy® Front Air Flow for C0330, C0530, C0630 (B and C revisions only)	13/6	\$263
KPMFA309-B	Kit - Prodigy® Front Air Flow for C0830, C1030 (B revisions only)	15/7	\$333



**CU0415**



15" x 24" x 32"  
38.1 x 61.0 x 96.5 cm  
(Add 5.5" (14cm) Height for legs)

**CU0715**



15" x 24" x 32"  
38.1 x 61.0 x 96.5 cm  
(Add 5.5" (14cm) Height for legs)

**CU0920**



20" x 24" x 32"  
50.8 x 61.0 x 96.5 cm  
(Add 5.5" (14cm) Height for legs)



Cube Size	Model Number	Condenser Type	24 hr Ice Production			Storage Capacity lb/kg AHRI	Shipping Weight lb/kg	List Price Volts/Hz/Phase			
			70°F/21°C 50°F/10°C lb/kg	Air Water	90°F/32°C 70°F/21°C lb/kg			115/60/1 -1	208-230/60/1 -32	230/50/1 -6	
Med.	<b>CU0415</b>	Air	58/26		38/17	36/16	102/46	\$3,295		\$3,420 ●	
	— CU0415MA										
Med.	<b>CU0715</b>	Air	80/36		58/26	36/16	102/46	\$3,627		\$3,752 ●	
	— CU0715MA										
Med.	<b>CU0920</b>	Air	100/45		80/36	57/26	115/52	\$3,870		\$3,995 ●	
	— CU0920MA										
<b>Optional Kits</b>		<b>Description</b>									
	KUFM15	For ADA applications. Lowers CU0415 and CU0715 height to 31.9"						3/1			\$174
	KUFM20	For ADA applications. Lowers CU0920 height to 31.9"						3/1			\$183

## Prodigy® Self-Contained Undercounter Cubers



Unit Dimensions (W x D x H)	Cube Size	Model Number	Condenser Type	24 hr Ice Production			Storage Capacity lb/kg AHRI	Shipping Weight lb/kg	List Price Volts/Hz/Phase		
				70°F/21°C 50°F/10°C lb/kg	Air Water	90°F/32°C 70°F/21°C lb/kg			115/60/1 -1	208-230/60/1 -32	230/50/1 -6
<p>26" x 27 3/8" x 33" 66.0 x 69.5 x 83.8 cm (Add 6" (15.2cm) Height for legs)</p>	Med. sm.	<b>CU1526</b>	Air	150/68		101/46	80/36	150/68	\$4,379		
		— CU1526MA									
		— CU1526MW									
		— CU1526SA									
	Med. sm.	— CU1526SW	Water	150/68		101/46	80/36	150/68	\$4,379		
		— CU1526SA	Air	150/68		101/46	80/36	150/68	\$4,379		
		— CU1526SW	Water	184/84		130/59	80/36	150/68	\$4,379		
		— CU1526SA	Air	184/84		130/59	80/36	150/68	\$4,379		
Med. sm.	<b>CU2026</b>	Air	218/99		145/66	80/36	175/80	\$4,973	\$5,048	\$5,098 ●	
	— CU2026MA										
	— CU2026SA										
	— CU2026SW										Water
Med. sm.	— CU2026SW	Water	224/101		172/78	80/36	175/80	\$4,973	\$5,048	\$5,098 ●	
	— CU2026SA	Air	224/101		172/78	80/36	175/80	\$4,973	\$5,048	\$5,098 ●	
	— CU2026SW	Water	224/101		172/78	80/36	175/80	\$4,973	\$5,048	\$5,098 ●	
	— CU2026SA	Air	224/101		172/78	80/36	175/80	\$4,973	\$5,048	\$5,098 ●	
<p>30" x 30" x 33" 76.2 x 76.2 x 83.8 cm (Add 6" (15.2cm) Height for legs)</p>	Med. sm.	<b>CU3030</b>	Air	313/142		224/102	110/50	200/91	\$5,781 ✓	\$5,856 ✓	\$5,906 ●
		— CU3030MA									
		— CU3030SA									
		— CU3030SW									
Med. sm.	— CU3030SW	Water	347/158		282/128	110/50	200/91	\$5,781		\$5,906 ●	
	— CU3030SA	Air	347/158		282/128	110/50	200/91	\$5,781		\$5,906 ●	
	— CU3030SW	Water	347/158		282/128	110/50	200/91	\$5,781		\$5,906 ●	
	— CU3030SA	Air	347/158		282/128	110/50	200/91	\$5,781		\$5,906 ●	
<b>Optional Kits</b>											
	KPUFM26	Kit - Prodigy® Undercounter Floor Mount for CU1526 & CU2026.						3/1			\$187
	KPUFM30	Kit - Prodigy® Undercounter Floor Mount for CU3030.						3/1			\$212



✓ = Energy Star certified. ● = CE Approved.

Combine model number and electrical indicator when ordering for exact SKU, i.e. C0322MA-1. See page 16 for storage bins.



# Self Contained Gourmet Cubers



Unit Dimensions (W x D x H)	Model Number	Condenser Type	24 hr Ice Production		Storage Capacity lb/kg AHRI	Shipping Weight lb/kg	List Price Volts/Hz/Phase		
			70°F/21°C 50°F/10°C lb/kg	Air Water lb/kg			90°F/32°C 70°F/21°C lb/kg	115/60/1 -1	208-230/60/1 N/A
 14 7/8" x 23 15/16" x 33 3/8" 37.78 x 60.80 x 84.77 cm	<b>CU50</b>	Air Air	65/30 65/30	Air Water	26/12 26/12	100/45 105/48	\$3,984 \$4,709		
	CU50GA CU50PA*								
 15 3/16" x 23 5/8" x 28 7/8" 38.6 x 60 x 73.3 cm (Add 5.25" (13.3cm) Height for legs)	<b>CU0515</b>	Air	84/38	Air Water	24/11	95/43	\$4,836 (Price includes legs)		
	CU0515GA								

Standard exterior finish: Stainless Steel.  
 \*CU50PA-1A comes with a pump drain instead of a gravity drain.

# Prodigy Plus® Eclipse® Ice Machines



<b>EH222SL</b>	<b>EH330SL</b>	<b>EH430SL / ML</b>
		
22" x 16.5" x 29" 55.9 x 41.9 x 71.1 cm	30" x 24" x 23" 76.2 x 61.0 x 58.4 cm	30" x 24" x 29" 76.2 x 61.0 x 71.1 cm

Cube Size	Model Number	Use With Condensing Unit	24 hr Ice Production		Shipping Weight lb/kg	List Price Volts/Hz/Phase	
			70°F/21°C 50°F/10°C lb/kg	Air Water lb/kg		90°F/32°C 70°F/21°C lb/kg	115/60/1 -1
Sm.	<b>Ice Maker</b> EH222SL	ECC0800 ECC1410	850/386 1030/468	Air Water	215/98 225/102	\$5,500 \$5,500	\$5,700 ●
	EH330SL						
Sm.	<b>Ice Maker</b> EH330SL	ECC1200	1330/604		310/141	\$6,027	
Sm. / Med.	<b>Ice Maker</b> EH430SL / ML	ECC1410 ECC1800	1425/648 1775/807	Air Water	225/102 235/107	\$6,266 ✓ \$6,266 ✓	

## ECC Features

- Energy efficient components save money on utility costs.
- Better corrosion resistance increases life of unit.
- One piece design makes installation and service easier.
- Maximizes air conditioning load.
- Allows for quiet operation in dining and working environments.
- Able to operate in wide outdoor temperature range from -20° F to 120° F.

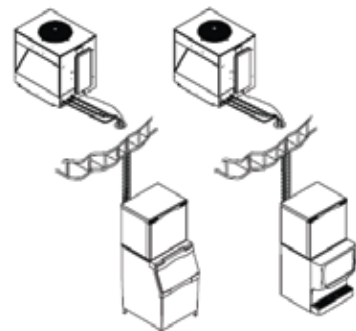

8. ✓ = Energy Star certified. ● = CE Approved.  
 Combine model number and electrical indicator when ordering for exact SKU, i.e. C0322MA-1. See page 16 for storage bins.





+



=

**Eclipse®**  
SYSTEM\*

Approx. Ice Production (lb.)	Ice Maker Small Cube	Ice Maker List Price	Condensing Unit	Condensing List Price	System List Price
800	EH222SL	\$5,500	ECC0800	\$6,793	\$12,293
1000	EH222SL	\$5,500	ECC1410	\$8,161	\$13,661
1400	EH330SL	\$6,027	ECC1200	\$8,172	\$14,199
1400	EH430SL / ML	\$6,266	ECC1410	\$8,161	\$14,427 ✓
1800	EH430SL / ML	\$6,266	ECC1800	\$11,976	\$18,242 ✓✓

\*Line sets and bin top kits must be purchased with Eclipse® System for proper operation of equipment.

## Prodigy Plus® Eclipse® Condensing Unit

Unit Dimensions (W x D x H)	Model Number	Description	Shipping Weight lb/kg	List Price Volts/Hz/Phase		
				208-230/60/1-32	208-230/60/3-3	230/50/1-6
 27" x 32.06" x 39.75" 68.58 x 81.4 x 100.9 cm	<b>Remote Condensers</b>					
	ECC0800	Remote condensing unit Eclipse 800 lb/364 kg systems	310/141		\$6,793	\$6,818
	ECC1200	Remote condensing unit Eclipse 1400 lb/636 kg systems	310/141	\$8,172		
	ECC1410	Remote condensing unit Eclipse 1000-1400 lb /455-636 kg systems	310/141	\$8,161	\$8,336	
	ECC1800	Remote condensing unit Eclipse 1800 lb/818 kg systems	310/141		\$11,976	

## Prodigy Plus® Eclipse® Accessories

Model Number	Description	Shipping Weight lb/kg	List Price
<b>Line Sets</b>			
3BRTE20-EH	Line set, 20ft. Refrigerant and Brazing required.	21/10	\$310
3BRTE35-EH	Line set, 35ft. Refrigerant and Brazing required.	32/15	\$440
3BRTE50-EH	Line set, 50ft. Refrigerant and Brazing required.	53/24	\$660
3BRTE75-EH	Line set, 75ft. Refrigerant and Brazing required.	79/36	\$980
KTE6-EH	Kit, Tube End, 6 Fittings, 3RTExx-EH Lineset	5/2	\$565



✓ = Energy Star certified. ● = CE Approved.



Combine model number and electrical indicator when ordering for exact SKU, i.e. C0322MA-1. See page 16 for storage bins.

# Prodigy Plus® Modular Flake Ice Machines

\*Refer to page 18 & 20 for required bin tops.



Unit Dimensions (W x D x H)	Model Number	Condenser Type	24 hr Ice Production			Shipping Weight lb/kg	List Price Volts/Hz/Phase		
			70°F/21°C 50°F/10°C lb/kg	Air Water	90°F/32°C 70°F/21°C lb/kg		115/60/1 -1	208-230/60/1 -32	230/50/1 -6
 22" x 24" x 23" 55.9 x 61.0 x 58.4 cm	<b>F0522</b>	Air Water	450/205 530/240		343/156 429/195	173/78 173/78	\$7,135 \$7,135		
	F0522A F0522W								
 22" x 24" x 23" 55.9 x 61.0 x 58.4 cm	<b>F0822</b>	Air Remote Water	800/363 760/345 775/352		641/291 631/287 654/297	175/79 175/79 175/79	\$9,067 \$8,967 \$9,067	\$9,117	
	F0822A F0822R F0822W								

Unit Dimensions (W x D x H)	Model Number	Condenser Type	24 hr Ice Production			Shipping Weight lb/kg	List Price Volts/Hz/Phase		
			70°F/21°C 50°F/10°C lb/kg	Air Water	90°F/32°C 70°F/21°C lb/kg		208-230/60/1 -32	208-230/60/3 -3	230/50/1 -6
 22" x 24" x 27" 55.9 x 61.0 x 68.6 cm	<b>F1222</b>	Air Remote Water	1000/454 1250/567 1240/562		878/395 907/409 967/436	220/100 220/100 220/100	\$11,434 ✓ \$11,334 ✓ \$11,434	\$11,609 ✓ \$11,509 ✓	\$11,659 ●
	F1222A F1222R F1222W								
 22" x 24" x 27" 55.9 x 61.0 x 68.6 cm	<b>F1522</b>	Air	1570/712		1100/499	224/102	\$14,985 ✓		
	F1522A								

## Scotsman Nugget Ice®, The Original Chewable Ice®





Scotsman Ice Systems introduced the first Nugget ice machine in 1981 and today ice-chewing fanatics have embraced Nugget ice, which is soft and chewy. In fact, some of these chewers are looking for bags - not just cups - of Scotsman Nugget Ice®, creating a great opportunity for restaurants and convenience stores to add a new, high margin, repeat-business product customers really want. And, Nugget ice makers from Scotsman can transform that opportunity into profit.

Beyond their crunch appeal, the slow-melting Nugget ice form cools drinks rapidly without foaming, and Nuggets displace more liquid than cube ice, lowering costs per cup. Nugget ice also consumes up to 50% less water and 15% less energy than cube machines. It all adds up to new customers, increased sales and a stronger bottom line.

✓ = Energy Star certified. ● = CE Approved.



Unit Dimensions (W x D x H)	Model Number	Condenser Type	24 hr Ice Production		Shipping Weight lb/kg	List Price Volts/Hz/Phase		
			70°F/21°C 50°F/10°C lb/kg	Air Water		90°F/32°C 70°F/21°C lb/kg	115/60/1 -1	208-230/60/1 N/A
 22" x 24" x 23" 55.9 x 61.0 x 58.4 cm	<b>N0422</b>	Air Water	420/191 455/206	Water	172/78 172/78	\$7,320 \$7,320		
	N0422A							
	N0422W							

Unit Dimensions (W x D x H)	Model Number	Condenser Type	24 hr Ice Production		Shipping Weight lb/kg	List Price Volts/Hz/Phase		
			70°F/21°C 50°F/10°C lb/kg	Air Water		90°F/32°C 70°F/21°C lb/kg	115/60/1 -1	208-230/60/1 -32
 22" x 24" x 23" 55.9 x 61.0 x 58.4 cm	<b>N0622</b>	Air Remote Water	643/292 660/299 715/325	Water	172/78 172/78 172/78	\$9,684 \$9,584 \$9,684	\$9,759	\$9,809 ●
	N0622A							
	N0622R							
	N0622W							

Unit Dimensions (W x D x H)	Model Number	Condenser Type	24 hr Ice Production		Shipping Weight lb/kg	List Price Volts/Hz/Phase		
			70°F/21°C 50°F/10°C lb/kg	Air Water		90°F/32°C 70°F/21°C lb/kg	208-230/60/1 -32	208-230/60/3 -3
 22" x 24" x 27" 55.9 x 61.0 x 68.6 cm	<b>N0922</b>	Air Remote Water	956/438 1044/474 1094/496	Water	210/95 210/95 210/95	\$12,090 ✓ \$11,990 ✓ \$12,090		\$12,315 ●
	N0922A							
	N0922R							
	N0922W							

Unit Dimensions (W x D x H)	Model Number	Condenser Type	24 hr Ice Production		Shipping Weight lb/kg	List Price Volts/Hz/Phase		
			70°F/21°C 50°F/10°C lb/kg	Air Water		90°F/32°C 70°F/21°C lb/kg	208-230/60/1 -32	208-230/60/3 -3
 22" x 24" x 27" 55.9 x 61.0 x 68.6 cm	<b>N1322</b>	Air Remote Water	1180/535 1329/602 1354/614	Water	225/102 225/102 225/102	\$15,389 ✓ \$15,289 ✓ \$15,389	\$15,564	\$15,614 ●
	N1322A							
	N1322R							
	N1322W							

# Prodigy Plus® Remote Low Side Flake and Nugget Complete Packages

\*Refer to page 18 & 20 for required bin tops.

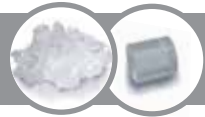

OR



+



=

Remote Low Side Flake and Nugget Complete Packages

Approx. Ice Production (lb.)	Flaker Ice Machine	Ice Maker List Price	Nugget Ice Maker	Ice Maker List Price	Condensing Unit	Cond. Unit List Price	Flaker System Price	Nugget System Price
1000	F1222L	\$9,491	N0922L	\$10,055	NME954-RHS-A/C	\$6,849	\$16,340	\$16,904

# Prodigy Plus® Remote Low Side Flake and Nugget Complete Packages

\*Refer to page 18 & 20 for required bin tops.

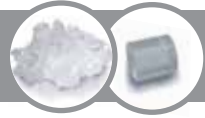

Unit Dimensions (W x D x H)	Model Number	Ice Form	24 hr Ice Production		Shipping Weight lb/kg	List Price Volts/Hz/Phase
			70°F/21°C 50°F/10°C lb/kg	Air Water 90°F/32°C 70°F/21°C lb/kg		
 22" x 24" x 27" 55.9 x 61.0 x 68.6 cm	<b>Flaker</b>	Flake Flake	1180/535 1445/655	1000/454 1205/547	217/98 224/102	115/60/1 -1 208-230/60/1 N/A
	F1222L					
	F1522L	\$12,106				
	<b>Nugget</b>	Nugget Nugget	1090/494 1330/605	915/415 1100/499	217/98 224/102	\$10,055 \$12,552
N0922L						
N1322L						

# Modular and Remote Low Side Flake and Nugget Ice Machines



Unit Dimensions (W x D x H)	Model Number	Condenser Type	24 hr Ice Production		Shipping Weight lb/kg	List Price Volts/Hz/Phase
			70°F/21°C 50°F/10°C lb/kg	Air Water 90°F/32°C 70°F/21°C lb/kg		
 42" x 24" x 27" 106.7 x 61.0 x 68.6 cm	<b>Flaker</b>	Air Remote Low Side	2455/1116 2365/1075	1400/635 2000/909	425/193 255/115	208-230/60/1 -32 230/50/1 -6
	FME2404AS					
	FME2404RLS	\$18,187				
	<b>Nugget</b>	Remote	2185/993	1825/829	425/193	\$22,805
NME1854RS						

# Remote Condensing Units for Remote Low Side Flake and Nugget Ice Machines

Unit Dimensions (W x D x H)	Model Number	Refrigerant	Description	Shipping Weight lb/kg	List Price Volts/Hz/Phase
 29 1/2" x 28 5/8" x 38 1/2" 74.9 x 72.7 x 97.8 cm	<b>Remote Condensing Units</b>	R-404A	Condensing Unit for N0922L and F1222L	220/87	\$6,849
	NME954-RHS-A/C				

✓ = Energy Star certified. ● = CE Approved.

# Remote Low Side Flake and Nugget Accessories

Model Number	Description	Shipping Weight lb/kg	List Price
<b>Line Sets</b>			
NRTE45	45 ft. (13.7 m) non-precharged line set for remote low side flaker and nugget ice machines.	17/8	\$545

# Flake & Nugget Ice Machine Kits and Accessories

Unit Dimensions (W x D x H)	Model Number	Description	Shipping Weight lb/kg	List Price Volts/Hz/Phase
	<b>Remote Condensers</b>			115/60/1 -1    208-230/60/1 -32    230/50/1 -6
29 1/2" x 29 1/8" x 38 15/32" 74.9 x 74.0 x 97.7 cm	ERC111	Remote condenser for F0822R or N0622R	95/43	\$1,828
29 1/2" x 29 1/8" x 38 15/32" 74.9 x 74.0 x 97.7 cm	ERC311	Remote condenser for F1222R, N0922R or N1322R	130/59	\$1,929    \$2,054
28 1/2" x 39" x 34 5/8" 72.4 x 99.1 x 87.9 cm	PR2C240	Remote condenser for 2-F1222R, 2-N0922R, 1-NME1854R	135/61	\$2,948

Note: PR2C40-32A requires two line sets per ice machine when used with NME1854R; PRC2C40-32A requires two KPFHM kits when used with 2-F1222R or N0922R units.

Model Number	Description	Shipping Weight lb/kg	List Price
<b>Line Sets</b>			
RTE10	10 ft (3.0 m) precharged R-404A tubing	7/3	\$364
RTE25	25 ft (7.6 m) precharged R-404A tubing	12/5	\$506
RTE40	40 ft (12.2 m) precharged R-404A tubing	17/7	\$557
RTE75	75 ft (22.9 m) precharged R-404A tubing	35/15	\$807
KTE4	Tube end kit - Contains 4 quick connect fittings for any RTE Line Set	5/2	\$185
<b>Miscellaneous</b>			
KERCF	Air filter for ERC111 or ERC311	5/2	\$135
KPFHM	Headmaster Kit for use with ERC101, ERC151, ERC201, ERC302 or PR2C240	10/5	\$298
KCMR-230	Fan relay kit for two 230V units connected to PR2C240 condenser	5/2	\$226
<b>Prodigy Modular Flaker &amp; Nugget Accessories</b>			
KPAS	Kit-Prodigy Advanced Sustainability. Includes KSBU-N and KVS	10/4	\$1,022
KSBU	Kit-Prodigy Smart-Board™ - Use additional operational data for fast diagnosis	5/2	\$687
KSBU-N	Kit-Prodigy Smart-Board™ - Network connection	5/2	\$898
KVS	Kit-Prodigy Vari-Smart™ Ice Level Control - Adjust ice levels to match ice needs	5/2	\$308

# Self-Contained Flake Ice Machines



Unit Dimensions (W x D x H)	Model Number	Condenser Type	24 hr Ice Production		Storage Capacity lb/kg AHRI	Shipping Weight lb/kg	List Price Volts/Hz/Phase		
			70°F/21°C 50°F/10°C lb/kg	Air Water			90°F/32°C 70°F/21°C lb/kg	115/60/1 -1	208-230/60/3 N/A
 24 1/4" x 24" x 33" 61.6 x 61.0 x 83.8 cm (add 6" (15.2 cm) Height for legs)	<b>AFE424</b>								
	AFE424A	Air	395/180		250/113	80/36	185/84	\$7,787	\$7,912
	AFE424W	Water	395/180		300/136	80/36	185/84	\$7,787	

Standard exterior finish: Grey rotocast polyethylene. (Price includes legs)

✓ = Energy Star certified. ● = CE Approved.

Combine model number and electrical indicator when ordering for exact SKU, i.e. C0322MA-1. See page 16 for storage bins.



**HID312**



HID312A: 16.25" x 24.38" x 35"  
HID312AW: 18.25" x 24.38" x 35"

**HID525**



HID525A: 21.25" x 24.38" x 35"  
HID525AW: 23.25" x 24.38" x 35"  
HID525W: 21.25" x 24.38" x 35"

**HID540**



HID540A: 21.25" x 24.38" x 41"  
HID540AW: 23.25" x 24.38" x 41"  
HID525W: 21.25" x 24.38" x 41"

Model Number	Condenser Type	24 hr Ice Production		Storage Capacity lb/kg	Shipping Weight lb/kg	List Price Volts/Hz/Phase	
		70°F/21°C 50°F/10°C lb/kg	Air Water			90°F/32°C 70°F/21°C lb/kg	115/60/1 -1
<b>HID312</b>							
HID312A	Air	260/118		12/5	183/83	\$8,244	\$8,494 ●
HID312AW*	Air	260/118		12/5	188/85	\$8,544	
<b>HID525</b>							
HID525A	Air	500/227		25/11	208/94	\$12,081	\$12,331 ●
HID525AW*	Air	500/227		25/11	213/97	\$12,406	
HID525W	Water	500/227		25/11	208/94	\$12,081	
<b>HID540</b>							
HID540A	Air	500/227		40/18	215/98	\$13,120	\$13,370 ●
HID540AW*	Air	500/227		40/18	220/100	\$13,470	
HID540W	Water	500/227		40/18	215/98	\$13,120	
KLP24A	4" adjustable legs, plastic with metal foot (box of 4)				5/2	\$84	

\*Wall mount configuration. Does not have drip tray. Designed to be installed over existing sink.

Meridian™ Icemaker / Dispenser Stands

**HST16-A**



HST16-A: 16.8" x 23.75" x 32"\*  
55.4 x 60.3 x 81.3 cm

**HST16B-A**



HST16-A: 16.8" x 23.75" x 32"\*  
55.4 x 60.3 x 81.3 cm

**HST21-A**



HST21-A: 21.8" x 23.75" x 32"\*  
42.7 x 60.3 x 81.3 cm

**HST21B-A**



HST21-A: 21.8" x 23.75" x 32"\*  
42.7 x 60.3 x 81.3 cm

Model Number	Description	Shipping Weight lb/kg	List Price
<b>Dispenser Kits</b>			
HST16-A	Stand with door, use with HID312, SS, includes 6" legs	50/23	\$1,265
HST16B-A	Stand for HID312, basic version, SS, includes 6" legs	50/23	\$1,164
HST21-A	Stand with door, use with HID525 & HID540, SS, includes 6" legs	80/36	\$1,306
HST21B-A	Stand for HID525 & HID540, basic version, SS, includes 6" legs	80/36	\$1,202

\*Height includes 6" legs.

✓ = Energy Star certified. ● = CE Approved.

# iceValet® Hotel / Motel Cube Dispensers

**HD22**



22" x 33 1/2" x 47 1/4"  
55.9 x 85.1 x 120.0 cm  
(add 6" (15.2 cm) Height for legs)

**HD30**



30" x 33 1/2" x 47 1/4"  
76.2 x 85.1 x 120.0 cm  
(add 6" (15.2 cm) Height for legs)

Model Number	Actuation	Storage Capacity	Shipping Weight	List Price	
		lb/kg AHRI	lb/kg	115/60/1 -1	230/50/1 -6
<b>HD22</b>	Push	120/59	200/91	\$5,630	\$5,755* ●
HD22B					
<b>HD30</b>	Push Water Filler	180/81 180/81	220/100 225/102	\$6,580 \$7,238	\$6,705* ● * Price includes legs
HD30B HD30W					

## Ice Only Counter Top Dispensers

Unit Dimensions (W x D x H)	Model Number	Actuation	Storage Capacity lb/kg	Shipping Weight lb/kg	List Price Volts/Hz/Phase 115/60/1 -1
 ID150: 22" x 30" x 35 5/8" 55.9 x 76.2 x 90.5 cm ID200: 30" x 30" x 35 5/8" 76.2 x 76.2 x 90.5 cm ID250: 30" x 30" x 39 5/8" 76.2 x 76.2 x 100.6 cm	<b>Ice Only Dispensers</b>				
	ID150B	Cup Activated	150/68	150/68	\$6,360
	ID200B	Cup Activated	200/91	195/89	\$7,617
	ID250B	Cup Activated	250/114	200/91	\$9,141





## Ice Only Dispenser Kits and Accessories

Unit Dimensions (W x D x H)	Model Number	Description	Shipping Weight lb/kg	List Price
 IOBDMS22: 22" x 30" x 24" 55.9 x 76.2 x 61.0 cm  IOBDMS30: 30" x 30" x 24" 76.2 x 76.2 x 61.0 cm (add 6" (15.2 cm) Height for legs)	<b>Machine Stands</b>	Machine stand for ID150 Machine stand for ID200 & ID250	93/42 120/55	\$1,775* \$1,784*
	IOBDMS22 IOBDMS30			
	<b>Kits</b>	Field installed water glass filler kit for ID150, ID200, & ID250 Field installed nugget ice kit for all ID dispensers	2/1 1/0.5	\$413 \$147
	KWGFID KNUGDIV			

\* Price includes legs

## Storage Bins

Model Number	Storage Capacity lb/kg AHRI	Ext. Finish	Liner Material	Unit Dimensions (W x D x H)	Shipping Weight lb/kg	List Price	
	<b>Modular Bins</b>						
	B322S	290/132	Metallic	Poly	22" x 34" x 44" (55.9 x 86.4 x 111.8 cm)	140/64	\$1,951
	B330P	270/123	Poly	Poly	30" x 34" x 31" (76.2 x 86.4 x 78.7 cm)	90/41	\$1,861
	B530P	420/191	Poly	Poly	30" x 34" x 44" (76.2 x 86.4 x 111.8 cm)	110/50	\$2,024
	B530S	420/191	Metallic	Poly	30" x 34" x 44" (76.2 x 86.4 x 111.8 cm)	150/68	\$2,150
	B842S	610/277	Metallic	Poly	42" x 34" x 44" (106.7 x 86.4 x 111.8 cm)	185/84	\$2,893
	B948S	700/319	Metallic	Poly	48" x 34" x 44" (121.9 x 86.4 x 111.8 cm) Add 6" (15.2 cm) height for legs	220/100	\$3,014 Price includes legs
	<b>BH Upright Modular Bins</b>						
	BH1100BB-A	860/393	SS w/GBB*	Poly	48" x 34" x 50" (121.9 x 86.4 x 127.0 cm)	280/127	\$6,729
	BH1100SS-A	860/393	SS	Poly	48" x 34" x 50" (121.9 x 86.4 x 127.0 cm)	280/127	\$8,248
	BH1300BB-A	1100/499	SS w/GBB*	Poly	60" x 34" x 50" (152.4 x 86.4 x 127.0 cm)	320/145	\$7,799
	BH1300SS-A	1100/499	SS	Poly	60" x 34" x 50" (152.4 x 86.4 x 127.0 cm)	320/145	\$9,535
	BH1600BB-A	1375/624	SS w/GBB*	Poly	60" x 34" x 62" (152.4 x 86.4 x 157.5 cm)	370/168	\$8,296
	BH1600SS-A	1375/624	SS	Poly	60" x 34" x 62" (152.4 x 86.4 x 157.5 cm) Add 6" (15.2 cm) height for legs	370/168	\$10,021 Price includes legs



\* Stainless steel with galvanized back and bottom

Bins include adjustable bin top filler panels for use with most ice machines. (See machine bin sizing chart on back page for special configurations). No extra charge for special bin tops when ordered with new bin purchase, except for field installed kit KBT50 - KBT54 bin tops. See page 18 for purchase price for field installed bin tops.

# Ice Express System Built-to-Order Only

Unit Dimensions (W x D x H)	Model Number	Description	Storage Capacity	Ext. Finish	Liner Material	Shipping Weight lb/kg	List Price
 <p>ICS-1 30" x 36" x 65" 76.2 x 91.4 x 165 cm</p> <p>ICS-2 60" x 36" x 71" 152.4 x 91.4 x 180.3 cm</p> <p>ICS-3 90" x 36" x 71" 228.6 x 91.4 x 180.3 cm</p> <p>ICS-3-SL 90" x 36" x 101" 228.6 x 91.4 x 256.5 cm</p>	<b>Ice Express System</b>						
	ICS-1	1 Bay*	500/227	SS	Poly	320/145	\$13,506
	ICS-2	2 Bay*	1200/544	SS	Poly	530/241	\$24,467
	ICS-3	3 Bay*	1800/817	SS	SS	950/432	\$37,954
	ICS-3-SL	3 Bay with extension*	2900/1315	SS	SS	1190/541	\$46,773
	<b>Options</b>						
	ICS-PADDLE	Replacement paddle, white plastic	N/A	N/A	N/A	11/5	\$379
	ICS-SHOVEL	Shovel, white plastic	N/A	N/A	N/A	11/5	\$379
	ICS-CP	Replacement Poly Cart	250/113	Poly	Poly	100/45	\$3,476
	ICS-TOTE	Ice Totes - Set of 6	N/A	Poly	Poly	25/11	\$1,206
ICS-DIVIDE	Ice Express - SS divider	N/A	N/A	N/A	70/32	\$2,040	
* Includes 1 poly cart for each bay. NOTE: All ICS systems & accessories ship F.O.B. Denver.							

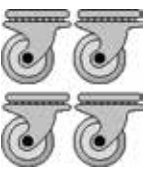
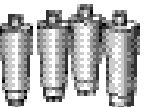
## Bin Accessories

Unit Dimensions (W x D x H)	Model Number	Description	Shipping Weight lb/kg	List Price
	<b>Caster Kits</b>			
	KBC1	Bin caster kit for B530S, B842S, B948S, SB480, CU1526, CU2026, CU3030, BH bins and AFE [3.5" (8.9 cm) diameter wheels, 2 standard wheels and 2 locking. Raises bin 4 7/16" (11.3 cm)] - Not to be used with SB480 when using extension or B222S or B322S.	8/4	\$339
	KBC1P	Bin caster kit for B330P and B530P. [3.5" (8.9 cm) diameter wheels, 2 standard wheels and 2 locking. Raises bin a maximum of 4 7/16" (11.3 cm).	20/9	\$439
	<b>Leg Kits</b>			
	KLP7	Kit, legs, 6" black enamel, flanged feet, B Bins, HST stands, HD dispensers, AFE, CU0515, CU1526, CU2026 and CU3030.	5/2	\$166
	KLP8S	Kit, legs, 6" stainless steel, Bx22, Bx30, B842, B948 and BH bins, HST stands, HD dispensers CU1526, CU2026, CU3030 and AFE. Note: Legs are supplied with self-contained machines, bins and machine stands.	5/2	\$274
 <p>19 1/4" x 10 3/4" x 28 1/2" 48.9 x 27.3 x 72.4 cm</p>	<b>Ice Bagger</b>			
	BGS10	Hooks over any ice bin opening. Aluminum.	25/11	\$675
	KBAG	Case of 1000 8lb bags.	30/14	\$317
	KTAPE	One roll - 180 ft (54.9 m)	1/0.5	\$45
	KSEALER	Tape sealer.	5/2	\$386
Note: BGS10 includes easy bagger, wicket of bags (250), tape sealer and 1 roll of tape.				
	<b>Ice Scoop Holder</b>			
	KHOLDER	Stainless steel scoop holder. Fits all B330, B530, B842 and B948 ice storage bins	2/1	\$100

## Bin Top Kits

Model Number	Description	Shipping Dimensions L x W x H	Use On	Shipping Weight lb/kg	List Price
KBT14A	NME1854, FME2404	10" x 27" x 5"	B948	8/4	\$307
KBT22A	All 30" (76.2 cm) modular cubers, flakers or nugget makers	17" x 29" x 5"	B948	11/5	\$330
KBT27	All 22" (55.9 cm) modular cubers, flakers or nugget makers except EH222	10" x 27" x 5"	B330, B530	8/4	\$304
KBT29	All 30" (76.2 cm) modular cubers	14" x 27" x 7"	B842	10/5	\$345
KBT38	All 22" (55.9 cm) modular cubers, flakers and nugget makers except EH222	6" x 30" x 17"	B948	14/7	\$386
KBT38-2X	All 22" (55.9 cm) modular cubers, flakers and nugget makers except EH222 side by side	10" x 27" x 5"	B948	5/2	\$224
KBT39	All 22" (55.9 cm) modular cubers, flakers and nugget makers except EH222	14" x 27" x 7"	B842	10/5	\$350
KBTABS	EH222	26" x 24" x 7"	ABS	24/11	\$1,292
KBT40A	EH222	26" x 24" x 7"	ID150	24/11	\$1,212
KBT41	EH222	32" x 32" x 5"	ID200, ID250	25/11	\$1,408
KBT42	All 22" modular ice machines except EH222	31" x 33" x 5"	ID150	12/5	\$603
KBT43	All 22" modular cubers and nugget makers except EH222	33" x 47" x 5"	ID200, ID250	26/12	\$805
KBT44	All 30" modular cubers	32" x 33" x 2"	ID200, ID250	13/5	\$559
KBT45	EH222	32" x 31" x 5"	ED300	33/15	\$2,882



## Field Installed - BH1100, BH1300, BH1600

Model Number	Description	Shipping Dimensions L x W x H	Use On	Shipping Weight lb/kg	List Price
KBT50	SS top for EH222	36" x 63" x 5"	BH1100	80/36	\$1,825
KBT51	SS top for (2) 22" (55.9 cm) units side-by-side	36" x 63" x 5"	BH1100	80/36	\$1,839
KBT52	SS top for EH222	36" x 63" x 5"	BH1300, BH1600	80/36	\$2,018
KBT53	SS top for (2) 22" (55.9 cm) units side-by-side	36" x 63" x 5"	BH1300, BH1600	80/36	\$2,018
KBT54	SS top for (2) 30" (76.2 cm) cubers side-by-side	36" x 63" x 5"	BH1300, BH1600	80/36	\$2,018

## Accessory Kits

Model Number	Description	Shipping Weight lb/kg	List Price
<b>Prodigy Plus® Nugget Dispenser Accessory Kits</b>			
KDIL-PN-150	Kit, Ice Level Control with KVS, Prodigy Nugget on Cornelius DF or ED150	2/1	\$853
KDIL-PN-200	Kit, Ice Level Control with KVS, Prodigy Nugget on Cornelius DF or ED200	5/2	\$912
KDIL-PN-250	Kit, Ice Level Control with KVS, Prodigy Nugget on Cornelius DF or ED250	5/2	\$1,018
KDIL-PN-ID3	Kit, Ice Level Control with thermostat, Prodigy Nugget on Cornelius DF or ED300	2/1	\$165
KFSMF	Kit, manual fill nugget for Coca Cola Freestyle 9000 dispenser	3/1	\$275
KFSTM	Kit, top mounted nugget for Coca Cola Freestyle 9000 dispenser	3/1	\$275

# AquaDefense® System - Sanitation Solution

Unit Dimensions (W x D x H)	Model Number	Description	Shipping Weight lb/kg	List Price
	<b>AquaBullet® Anti Microbial Wand</b>	6 pack of Antimicrobial wands to prevent slime and mold build up. Used for modular cube ice machines.	5/2	\$1,107
	ADS-AB6			
 AP1-P 5 5/8" x 4 3/4" x 21 1/2" 14.3 x 12.1 x 54.6 cm AP2-P 16 1/2" x 5 1/2" x 19 1/4" 41.9 x 14.0 x 48.9 cm AP3-P 21" x 5 1/2" x 19 1/4" 53.3 x 14.0 x 48.9 cm	<b>AquaPatrol™ Plus Water Filtration System</b>	Single system - Cubers up to 650 lb (395 kg), flakers, nuggets and nugget dispensers up to 1,200 lb (544 kg) Twin System - Cubers over 650 lb (395 kg) and up to 1,200 lb (544 kg), flakers and nuggets over 1,200 lb (544 kg) Triple System - Cubers over 1,200 lb (544 kg) Replacement cartridge (package of 6) Replacement cartridge (package of 1)	7/3	\$375
	AP1-P		11/5	\$680
	AP2-P		16/7	\$1,050
	AP3-P		7/3	\$590
	APRC6-P		3/1.5	\$118
	APRC1-P			

## Water Filtration Systems By Everpure®

Unit Dimensions (W x D x H)	Model Number	Description	Shipping Weight lb/kg	List Price
 SSM1 5 5/8" x 4 3/4" x 30 1/2" 14.3 x 12.1 x 77.5 cm SSM2 16 1/2" x 5 1/2" x 25 1/2" 41.9 x 14.0 x 64.8 cm SSM3 21" x 5 1/2" x 25 1/2" 53.3 x 14.0 x 64.8 cm	<b>SSM Plus Filtration Systems with AquaArmor by AgION®</b>	Single system - Cubers up to 650 lb (395 kg), flakers, nuggets and nugget dispensers up to 1,200 lb (544 kg) Twin System - Cubers over 650 lb (295 kg), flakers and nuggets over 1,200 lb (544 kg) Triple System - Cubers over 1,200 lb (544 kg)	7/3	\$499
	SSM1-P		11/5	\$863
	SSM2-P		16/7	\$1,376
	SSM3-P			
	<b>SSMRC Replacement Cartridges</b>	Single replacement cartridge (package of 1) 6 pack replacement cartridge (package of 6)	3/1.5	\$164
	SSMRC1 SSMRC6		7/3	\$804
	<b>SC Coarse Prefilters</b>	10" (25.4 cm) Coarse prefilter 20" (50.8 cm) Coarse prefilter	5/2	\$180
	SC10-A SC20-A		11/5	\$255
	<b>SC Replacement Prefilters</b>	SC10 replacement filter SC20 replacement filter	17/8	\$312
	SC10RC40 SC20RC20		17/8	\$330

## Better Filtration for Clear, Pure Ice.



### Water Filtration Systems

Assisting in the ice machine sanitation battle, the Scotsman Ice Systems AquaDefense® sanitation system is a common-sense multimethod approach to defending your ice machine against undesirable microbes, bacteria, mold and algae. The AquaDefense® sanitation system features advanced defensive means.

AquaPatrol Plus offers better protection now in a smaller footprint, higher capacity and better filtration capability.



# Machine/Bin Sizing Chart Dimensions in W x D x H - (Height includes 6" legs)

	BINS (Storage)	B322S	B330P	B530P/S	B842S	B948S	BH1100	BH1300	BH1600
ICE MAKERS (Production)	LBS	290	270	420	610	700	860	1100	1375
<b>C0322</b> <b>C0522</b>	300 500	22" x 34" x 73" 55.9 x 86.4 x 185.4 cm	30" x 34" x 59" 76.2 x 86.4 x 149.9 cm w/KBT27 top	30" x 34" x 73" 76.2 x 86.4 x 185.4 cm w/KBT27 top	42" x 34" x 73" 106.2 x 86.4 x 185.4 cm w/KBT39 top	48" x 34" x 73" 121.9 x 86.4 x 185.4 cm w/KBT38 top or KBT38-2x - side by side			
<b>C0722</b>	700	22" x 34" x 76" 55.9 x 86.4 x 193.0 cm	30" x 34" x 65" 76.2 x 86.4 x 165.1 cm w/KBT27 top	30" x 34" x 79" 76.2 x 86.4 x 200.7 cm w/KBT27 top	42" x 34" x 79" 106.2 x 86.4 x 200.7 cm w/KBT39 top	48" x 34" x 79" 121.9 x 86.4 x 200.7 cm w/KBT38 top or KBT38-2x - side by side	48" x 34" x 87" 121.9 x 86.4 x 221.0 cm KBT51 - side by side	60" x 34" x 87" 152.4 x 86.4 x 221.0 cm KBT53 - side by side	60" x 34" x 99" 152.4 x 86.4 x 251.5 cm KBT53 - side by side
<b>C0330</b> <b>C0530</b> <b>C0630</b>	300 500 600		30" x 34" x 59" 76.2 x 86.4 x 149.9 cm	30" x 34" x 73" 76.2 x 86.4 x 185.4 cm	42" x 34" x 73" 106.7 x 86.4 x 185.4 cm w/KBT29 top	48" x 34" x 73" 121.9 x 86.4 x 185.4 cm w/KBT22A top			
<b>C0830</b> <b>C1030</b>	800 1000			30" x 34" x 79" 76.2 x 86.4 x 200.7 cm	42" x 34" x 79" 106.2 x 86.4 x 200.7 cm w/KBT29 top	48" x 34" x 79" 121.9 x 86.4 x 200.7 cm w/KBT22A top	48" x 34" x 85" 121.9 x 86.4 x 215.9 cm	60" x 34" x 85" 152.4 x 86.4 x 215.9 cm No bin top or KBT54 - side by side	60" x 34" x 97" 152.4 x 86.4 x 246.4 cm No bin top or KBT54 - side by side
<b>C1448</b> <b>C1848</b> <b>C2148</b>	1400 1800 2000					48" x 34" x 79" 121.9 x 86.4 x 200.7 cm	48" x 34" x 85" 121.9 x 86.4 x 215.9 cm	60" x 34" x 85" 152.4 x 86.4 x 215.9 cm	60" x 34" x 97" 152.4 x 86.4 x 246.4 cm
<b>C2648</b>	2600					48" x 34" x 84" 121.9 x 86.4 x 213.4 cm	48" x 34" x 90" 121.9 x 86.4 x 228.6 cm	60" x 34" x 90" 152.4 x 86.4 x 228.6 cm	60" x 34" x 102" 152.4 x 86.4 x 259.1 cm
<b>EH222</b>	800 1000						48" x 34" x 85" 121.9 x 86.4 x 215.9 cm KBT50 - single unit KBT51 - side by side	60" x 34" x 85" 152.4 x 86.4 x 215.9 cm KBT52 - single unit KBT53 - side by side	60" x 34" x 85" 152.4 x 86.4 x 215.9 cm KBT52 - single unit KBT53 - side by side
<b>EH330</b>	1400				42" x 34" x 73" 106.2 x 86.4 x 185.4 cm w/KBT29 top	48" x 34" x 73" 121.9 x 86.4 x 185.4 cm w/KBT22A top	48" x 34" x 79" 121.9 x 86.4 x 200.7 cm	60" x 34" x 79" 152.4 x 86.4 x 200.8 cm KBT54 - side by side	60" x 34" x 91" 152.4 x 86.4 x 231.1 cm No bin top or KBT54 - side by side
<b>EH430</b>	1400 1800				42" x 34" x 79" 106.2 x 86.4 x 200.7 cm w/KBT29 top	48" x 34" x 79" 121.9 x 86.4 x 200.7 cm w/KBT22A top	48" x 34" x 85" 121.9 x 86.4 x 215.9 cm	60" x 34" x 85" 152.4 x 86.4 x 215.9 cm KBT54 - side by side	60" x 34" x 97" 152.4 x 86.4 x 246.4 cm No bin top or KBT54 - side by side
<b>N0422</b> <b>N0622</b>	400 600	22" x 34" x 73" 55.9 x 86.4 x 184.4 cm	30" x 34" x 59" 76.2 x 86.4 x 149.9 cm w/KBT27 top	30" x 34" x 73" 76.2 x 86.4 x 185.4 cm w/KBT27 top	42" x 34" x 73" 106.2 x 86.4 x 185.4 cm w/KBT39 top	48" x 34" x 73" 121.9 x 86.4 x 185.4 cm w/KBT38 top or KBT38-2x - side by side			
<b>N0922</b> <b>N1322</b>	900 1300	22" x 34" x 77" 55.9 x 86.4 x 195.6 cm	30" x 34" x 63" 76.2 x 86.4 x 160.0 cm w/KBT27 top	30" x 34" x 77" 76.2 x 86.4 x 195.6 cm w/KBT27 top	42" x 34" x 77" 106.2 x 86.4 x 195.6 cm w/KBT39 top	48" x 34" x 77" 121.9 x 86.4 x 195.6 cm w/KBT38 top or KBT38-2x - side by side	48" x 34" x 85" 121.9 x 86.4 x 215.9 cm KBT51 - side by side	60" x 34" x 85" 152.4 x 86.4 x 215.9 cm KBT53 - side by side	60" x 34" x 97" 152.4 x 86.4 x 246.4 cm KBT53 - side by side
<b>F0522</b> <b>F0822</b>	500 800	22" x 34" x 73" 55.9 x 86.4 x 184.4 cm	30" x 34" x 59" 76.2 x 86.4 x 149.9 cm w/KBT27 top	30" x 34" x 73" 76.2 x 86.4 x 185.4 cm w/KBT27 top	42" x 34" x 73" 106.2 x 86.4 x 185.4 cm w/KBT39 top	48" x 34" x 73" 121.9 x 86.4 x 185.4 cm w/KBT38 top or KBT38-2x - side by side	48" x 34" x 81" 121.9 x 86.4 x 205.7 cm KBT51 - side by side	60" x 34" x 81" 152.4 x 86.4 x 205.7 cm KBT53 - side by side	60" x 34" x 93" 152.4 x 86.4 x 236.2 cm KBT53 - side by side
<b>F1222</b> <b>F1522</b>	1200 1500	22" x 34" x 77" 55.9 x 86.4 x 195.6 cm	30" x 34" x 63" 76.2 x 86.4 x 160.0 cm w/KBT27 top	30" x 34" x 77" 76.2 x 86.4 x 195.6 cm w/KBT27 top	42" x 34" x 77" 106.2 x 86.4 x 195.6 cm w/KBT39 top	48" x 34" x 77" 121.9 x 86.4 x 195.6 cm w/KBT38 top or KBT38-2x - side by side	48" x 34" x 85" 121.9 x 86.4 x 215.9 cm KBT51 - side by side	60" x 34" x 85" 152.4 x 86.4 x 215.9 cm KBT53 - side by side	60" x 34" x 97" 152.4 x 86.4 x 246.4 cm KBT53 - side by side
<b>NME1854</b>	1825				42" x 34" x 77" 106.2 x 86.4 x 195.6 cm	48" x 34" x 77" 121.9 x 86.4 x 195.6 cm w/KBT14A top	48" x 34" x 83" 121.9 x 86.4 x 210.8 cm	60" x 34" x 83" 152.4 x 86.4 x 210.8 cm	60" x 34" x 95" 152.4 x 86.4 x 241.3 cm
<b>FME2404</b>	2020				42" x 34" x 77" 106.2 x 86.4 x 195.6 cm	48" x 34" x 77" 121.9 x 86.4 x 195.6 cm w/KBT14A top	48" x 34" x 83" 121.9 x 86.4 x 210.8 cm	60" x 34" x 83" 152.4 x 86.4 x 210.8 cm	60" x 34" x 95" 152.4 x 86.4 x 241.3 cm

No bin top required when KBT not listed.

Ice Only Dispensers

Hotel D-Bins

ABS	ID150	ID200	ID250	Cornelius ED300	HD22	HD30
150	150	200	250	300	120	180
	22" x 30 1/2" x 57 1/4" 55.9 x 77.5 x 145.4 cm w/KBT42 top	30" x 30 1/2" x 59" 76.2 x 77.5 x 149.9 cm w/KBT43 top	30" x 30 1/2" x 63" 76.2 x 77.5 x 160.0 cm w/KBT43 top		22" x 33 1/2" x 76 1/4" 55.9 x 85.1 x 193.7 cm	
	22" x 30 1/2" x 63 1/4" 55.9 x 77.5 x 160.7 cm w/KBT42 top	30" x 30 1/2" x 65" 76.2 x 77.5 x 165.1 cm w/KBT43 top	30" x 30 1/2" x 69" 76.2 x 77.5 x 175.3 cm w/KBT43 top		22" x 33 1/2" x 82 1/4" 55.9 x 85.1 x 208.9 cm	
		30" x 30 1/2" x 57 1/4" 76.2 x 77.5 x 145.4 cm w/KBT44 top	30" x 30 1/2" x 61 1/4" 76.2 x 77.5 x 155.6 cm w/KBT44 top	44" x 30 1/2" x 60" 112.7 x 77.5 x 152.4 cm w/Cornelius #629087943		30" x 33 1/2" x 76 1/4" 76.2 x 85.1 x 193.7 cm
		30" x 30 1/2" x 63 1/4" 76.2 x 77.5 x 160.7 cm w/KBT44 top	30" x 30 1/2" x 67 1/4" 76.2 x 77.5 x 170.8 cm w/KBT44 top	44 1/2" x 30 1/2" x 66" 112.7 x 77.5 x 170.8 cm w/Cornelius #629087943		
KBTABS	22" x 30 1/2" x 64 1/4" 55.9 x 77.5 x 163.2 cm w/KBT40A top	30" x 30 1/2" x 64 1/2" 76.2 x 77.5 x 163.2 cm w/KBT41 top	30" x 30 1/2" x 68 1/4" 76.2 x 77.5 x 173.4 cm w/KBT41 top	44 1/2" x 30 1/2" x 66" 112.7 x 77.5 x 167.6 cm w/KBT45 top		
		30" x 30 1/2" x 57 1/2" 76.2 x 77.5 x 145.4 cm w/KBT44 top	30" x 30 1/2" x 61 1/4" 76.2 x 77.5 x 145.4 cm w/KBT44 top	44 1/2" x 30 1/2" x 60 1/4" 112.7 x 77.5 x 153 cm w/Cornelius #629087943		
		30" x 30 1/2" x 63 1/4" 76.2 x 77.5 x 160.7 cm w/KBT44 top	30" x 30 1/2" x 67 1/4" 76.2 x 77.5 x 170.8 cm w/KBT44 top	44 1/2" x 30 1/2" x 66 1/4" 112.7 x 77.5 x 167.6 cm w/Cornelius #629087943		
	22" x 30 1/2" x 57 1/4" 55.9 x 77.5 x 145.4 cm w/KBT42 top KVS, KNUGDIV	30" x 30 1/2" x 59" 76.2 x 77.5 x 149.9 cm w/KBT43 top KVS, KNUGDIV	30" x 30 1/2" x 63" 76.2 x 77.5 x 160.0 cm w/KBT43 top KVS, KNUGDIV	44 1/2" x 30 1/2" x 64" 112.7 x 77.5 x 152.4 cm KDIL-PN-ID3 w/Cornelius #629087966 and #629088644		
	22" x 30 1/2" x 61 1/4" 55.9 x 77.5 x 155.6 cm w/KBT42 top KVS, KNUGDIV	30" x 30 1/2" x 63" 76.2 x 77.5 x 160.0 cm w/KBT43 top KVS, KNUGDIV	30" x 30 1/2" x 67" 76.2 x 77.5 x 170.2 cm w/KBT43 top KVS, KNUGDIV	44 1/2" x 30 1/2" x 64" 112.7 x 77.5 x 152.4 cm KDIL-PN-ID3 w/Cornelius #629087966 and #629088644		

# Ice Machine to Dispenser Kit Application Chart

Company	Dispenser	Ice Machines EH222	C0322/522/722	C0330/530/630/830 1030, EH330, EH430	N0422/622 922/1322
Cornelius	ED150	KBT40A	KBT42		KBT42 KDIL-PN-150
Cornelius	DF150	629087959*	02388*		02388* KDIL-PN-150
Cornelius	ED175	629087571*	629087907*		KDIL-PN-150 629087907*
Cornelius	ED200	KBT41	KBT43	KBT44	KBT43 KDIL-PN-200
	DF200	629087572*	08035*	08004*	
Cornelius	ED250	KBT41	KBT43	KBT44, KVS**	KBT43 KDIL-PN-250
	DF250	629087572	08035*	08004*, KVS**	
Cornelius	ED300	KBT45	08028*	629087943*	KDIL-PN-ID3 629087966* 629088644*
	DF300	KBT45	08028*	629087943*	
Cornelius	Flavor Fusion 255	629088666*	KVS** 629088502*	KVS** 629088505*	KVS 629088681* 629097086*
	IDC215/ID255	629088662*	KVS** 629088537*	KVS** 629088536*	KVS 629088677* 629097086*
Lancer	22" Wide	82-4063*	82-4062*		
Lancer	30" Wide	82-4061*	82-4060*	82-4059*, KVS**	
SerVend	S-150/SV-150	SL27-020000246*	SL30-020000249* CL10-5012116*		KVS SL30-020000249 CL10-5012116*
SerVend	SV-175	SL22-020000198*	SL24-020000200*		KVS SL24-020000200*
SerVend	S-200/SV-200 S-250/SV-250	SL17-5031150*	SL25-5031609*	N3-5031125* CL10-5012116*	KVS SL25-5031609*

\* Non Scotsman kits must be purchased from the dispenser manufacturer.

\*\* Recommended but not required.

- Please check with dispenser manufacturer for appropriate kits. Application chart subject to change.
- Blank cells indicate can not be used together, N/A indicates no adapter needed.
- See spare parts price list for Scotsman A37693-021 & R629088514 pricing.
- Lancer dispensers must be specially configured for dispensing Scotsman Nugget Ice®
- Some Cornelius adapters kits include binstats - do not use the thermostats.
- All Cornelius ED/DF adapter kits have grey doors/covers. Contact Cornelius for black.
- All Cornelius FlavorFusion adapter kits are midnight black. Contact Cornelius for silver, orange or green.
- All Cornelius IDC255 adapter kits are black.





Unit Dimensions (W x D x H)	Cube Size	Model Number	Condenser Type	24 hr Ice Production		Shipping Weight lb/kg	List Price Volts/Hz/Phase	
				70°F/21°C 50°F/10°C lb/kg	Air Water		90°F/32°C 70°F/21°C lb/kg	230/50/1 -6
 <p><b>MXGM438</b></p> <p>MXG328: 22" x 28" x 28" 56 x 70 x 72 cm</p> <p>MXG438: 30" x 28" x 28" 76.5 x 70 x 72 cm</p> <p>MXG638: 30" x 28" x 44" 76.5 x 70 x 112.5 cm</p> <p>MXG938: 30" x 28" x 49" 76.5 x 70 x 123.5 cm</p>	Med.	<b>MXG328</b> — MXGM328AS	Air	324/147		243/110	169/77	\$6,725 ●
	Med.	<b>MXG438</b> — MXGM438AS	Air	397/180		282/128	187/85	\$7,574 ●
	Med. Lg.	<b>MXG638</b> — MXGM638AS	Air	684/310		485/220	284/129	\$10,356 ●
		— MXGL638AS	Air	684/310		485/220	284/129	\$10,356 ●
	Med.	<b>MXG938</b> — MXGM938AS	Air	880/400		790/360	348/158	\$12,410 ●

Unit Dimensions (W x D x H)	Cube Size	Model Number	Condenser Type	24 hr Ice Production		Shipping Weight lb/kg	List Price Volts/Hz/Phase		
				70°F/21°C 50°F/10°C lb/kg	Air Water		90°F/32°C 70°F/21°C lb/kg	115/60/1 -1	208-230/60/3 N/A
 <p><b>ECM126</b></p> <p>ECM56: 15" x 23" x 27" 38.6 x 60 x 69.5 cm (add 5" (13.3 cm) Height for legs)</p> <p>ECM126: 26" x 23" x 36" 68 x 60 x 92 cm (add 5" (13.3 cm) Height for legs)</p> <p>ECM176: 26" x 23" x 39" 68 x 60 x 99 cm (add 5" (13.3 cm) Height for legs)</p>	Med.	<b>ECM56</b> — ECM56AS	Air	67/31		27/13	84/38		\$4,070* ●
	Med.	<b>ECM126</b> — ECM126AS	Air	145/66		86/39	143/65	\$4,623	\$4,755* ●
	Med.	<b>ECM176</b> — ECM176AS	Air	182/83		106/48	154/70	\$5,232	\$5,365* ● * Price includes legs

INTERNATIONAL PRODUCTS - Storage Bins

Unit Dimensions (W x D x H)	Model Number	Storage Capacity lb/kg Maximum	Ext. Finish	Linear Material	Shipping Weight lb/kg	List Price
 <p><b>SB550</b>: 42" x 32" x 32" 108.2 x 82.4 x 82.4 cm (add 6" (15.2 cm) Height for legs)</p>	<b>Modular Bins</b>	433/197	Stainless Steel	Poly	140/64	\$3,318* ● *Price includes legs
	SB550					



**International Warranty**

- MXG and bin models: 3 year parts, 1 year labor
- EC models: 3 year parts, 2 year labor



**Please Note:**

- Items are FOB Scotsman Ice (Italy)
- **Not qualified for installation in North America**

✓ = Energy Star certified. ● = CE Approved.

Combine model number and electrical indicator when ordering for exact SKU, i.e. C0322MA-1. See page 16 for storage bins.

# Commercial Products

Effective January 1, 2017

The Suggested List Price Schedule is intended only as a guideline to pricing. It does not restrict the price a distributor or dealer may establish. Pricing and specifications subject to change without notice.



## Warranty\*

### Prodigy Plus®, Eclipse® Cubers, iceValet® Hotel Dispensers & Bins

(EH, ERC, HD, BH, B, C0, C1, C2, CB, CU\* & PR)

- 3 years parts
- 3 years labor
- 5 years parts & labor on Prodigy Evaporator, BH1100, BH1300, BH1600 & ICS systems
- 5 years parts on compressor and condenser

### Prodigy Plus® and AutoSentry™ Flake and Nugget Ice Machines

(FM, NM, F & N)

- 3 years parts
- 3 years labor
- 5 years parts on compressor

### Other Flake Ice Machines

- (AFE)
- 2 years parts
- 2 years labor
- 5 years on compressor

### Other Cube Ice Machines

- (CU50)
- 1 years parts
- 1 years labor
- 5 years parts on compressor

### Essential Ice Cube Ice Machines

- (CU0415, CU0715, CU0920)
- 3 years parts
- 3 years labor

### Meridian™ Ice & Water Dispensers

- (HID)
- 3 years parts
- 3 years labor
- 5 years on compressor & condenser

### Water Filtration Systems

- (SSM & AP)
- 5 years on manifold parts only (SSMx-P & SCx0-A)

### Ice Only Dispensers

- (ID)
- 2 years parts
- 1 years labor

### Remote Condensing Units

- (RHS)
- 1 year parts

\* Warranty valid in North, South & Central American for commercial installations.



## Definitions

- Maximum production capabilities are typical peak production for 24 hours at 70°F/21°C air and 50°F/10°C water
- AHRI certified production capabilities are typical peak production for 24 hours at 90°F/32°C air and 70°F/21°C water
- Maximum capacity is based on 90% of total volume in cubic feet x 34 lb/ft<sup>3</sup>
- AHRI capacity is based on 80% of total volume in cubic feet x 30 lb/ft<sup>3</sup>
- (SS) Stainless Steel
- (RC) Rotocast Plastic
- (R-Air) Remote Air
- (RLS) Remote Lowside
- Freight F.O.B. Fairfax, South Carolina and Denver, Colorado, except international product F.O.B. Milan, Italy

# Scotsman®

- 101 Corporate Woods Parkway, Vernon Hills, IL 60061 •
- 1-800-SCOTSMAN • Fax: 847-913-9844 • www.scotsman-ice.com • customer.relations@scotsman-ice.com •



@ScotsmanIceSystems