

SCOTSMAN

AIR, WATER, & REMOTE COOLED MODULAR CONTOUR CUBERS

CME1656

VOLUME PRODUCTION • 24 HOUR



 Certified & rated in accordance with ARI standard 810-95	Air-Cooled		Water-Cooled		Remote	
	70°/50° lbs./kg.	ARI 90°/70° lbs./kg.	70°/50° lbs./kg.	ARI 90°/70° lbs./kg.	70°/50° lbs./kg.	ARI 90°/70° lbs./kg.
CME1656-32	1600/726	1250/567	1600/726	1440/655	1550/703	1400/635
CME1656-3	1600/726	1250/567	1600/726	1440/655	1550/703	1400/635

VALUE THE DIFFERENCE OF CM³ ICE MACHINES:

- CM³ series offers the lowest lifetime operating costs based on lower water and electrical usage. Combine that with a competitive purchase price and the best warranty in the industry and you have the lowest lifetime ownership cost. Period.
- AutoIQ™ Control System monitors and controls the ice machines' functions to ensure consistent ice production and reduce operating costs.
- CM³ Evaporator is a hot tin dipped, molecularly bonded plate that has been field tested and proven 99.4% reliable over 5 years.
- Rust-free Polyethylene Base and Food Zone is insulated with 1-1/2" of foam which keeps water and food zone cool to reduce operating costs and is backed by a Lifetime Rust-Free Warranty.
- Contemporary styling and stainless steel finish make the CM³ a perfect addition to any operation.
- Now protected with AquaArmor™ utilizing AgION™, a silver-based anti-microbial compound that reduces the growth of bacteria, microorganisms, algae, mold and slime on ice machine surfaces. AgION is a trademark of AgION Technologies and is registered with the EPA.

BIN OPTIONS:



BIN: BH900



BIN: BH1300

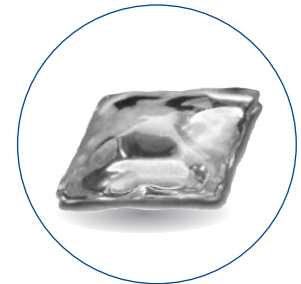

APPROX. CUBE SIZE:
1 3/8" x 1 3/8" x 5/8" THICK

SCOTSMAN MODULAR BINS		 Certified & rated in accordance with ARI standard 820-95			
Model Number	Dimensions W"xD"xH"*	ARI Bin Capacity lbs./kg.	Application Capacity lbs./kg.	Finish**	Ship Weight lbs./kg.
BH900	48.2 x 33.75 x 44	740/336	940/426	SS or BB	185/84
BH1100	48 x 34 x 50	860/393	1100/499	SS or BB	280/127
BH1300	60 x 34 x 50	1100/499	1400/635	SS or BB	310/140
BH1600	60 x 34 x 62	1375/624	1755/796	SS or BB	370/168

* Add 6" Height for Legs
** SS - All Stainless Steel with Polyethylene Liner.
BB - All Stainless Steel Except Galvanized Back and Bottom

This product qualifies for the following listings:



 Rated in accordance with ARI standard 810-95

AgION
ANTIMICROBIAL

CERTIFIED

 9001:2000



Ice Machine Specifications

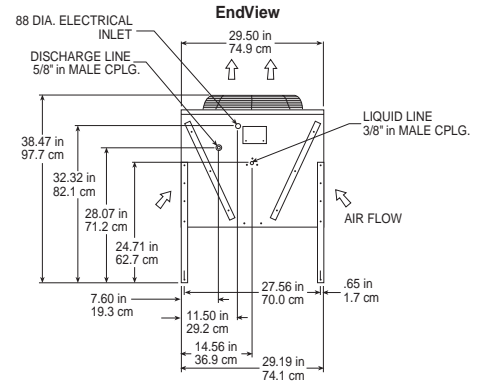
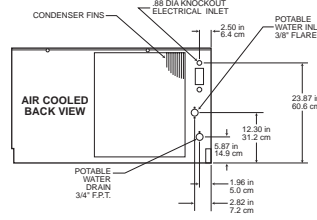
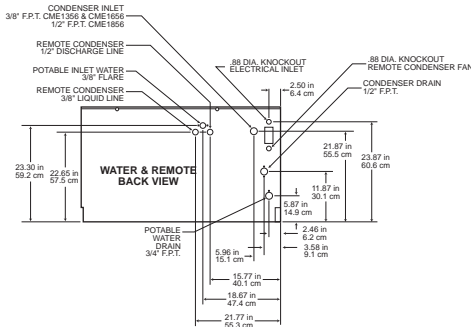
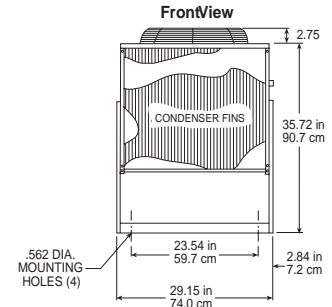
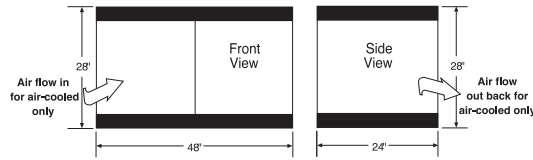
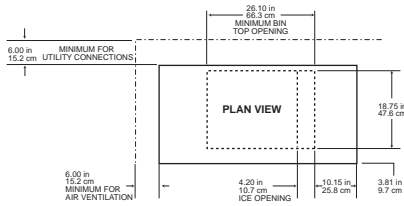

All models: Dimensions: W x D x H Unit: 48" x 24" x 28" Shipping Carton: 51" x 27" x 31"

Model Number	Condenser Unit	Basic Electrical Volts/Hz/Phase	Max. Fuse Size or HACR Circuit Breaker	Comp. HP	Circuit Wires	Min. Circuit Ampacity	BTU's per hour	Shipping Weight lbs./kg.	Power Consumption KWH/100 lbs. 90°F/70° F	Water Usage Gallons/100 lbs. Potable 90°F/70° F	Condenser 90°F/70° F
CME1656AS-32F	AIR	208-230/60/1	30	3.5	2	26.7	21,500	365/166	6.0	18.0	-
CME1656WS-32F	WATER	208-230/60/1	30	3.5	2	23.9	21,500	365/166	4.7	18.0	143.0
CME1656RS-32F	REMOTE	208-230/60/1	30	3.5	2	24.9	21,500	370/168	5.2	18.0	-
CME1656AS-3F	AIR	208-230/60/3	20	3.5	3	17.8	21,500	365/166	5.9	18.5	-
CME1656WS-3F	WATER	208-230/60/3	20	3.5	3	14.9	21,500	365/166	4.7	18.0	143.0
CME1656RS-3F	REMOTE	208-230/60/3	20	3.5	3	15.9	21,500	370/168	5.2	18.0	-

All units with Stainless Steel finish.

OPTIONS:

Stacking Kit: Number KSCME6-LG-B
Refrigerant - R404A

REMOTE CONDENSER— See ERC Spec Sheet for further details
Dimensions: W x D x H: 29.50" x 29.25" x 38.50"

Model Number	For Use With	Cond. Unit	Finish Basic	Electrical Volts/Hz/Phase	No. of Wires	Min. Circuit Ampacity	Max Fuse Size or HACR Circuit Braker
ERC411-32A	(1) CME1656R	Air	Galvanized	208-230/60/1	2	1.25	15

PRE-CHARGED REFRIGERANT TUBE KITS: 25-Foot, RTE25 • 40-Foot, RTE40 • 75-Foot, RTE75, R-404 Refrigerant

Scotsman's ice machines are not designed for outdoor installations. Scotsman remote condensers are designed for outdoor installations.

Machine requires voltage indicated on rating name plate. Failures caused by improper voltage are not considered factory defects. Extended periods of operation at temperatures exceeding limitations constitutes misuse under the terms of Scotsman Manufacturer's Limited Warranty, resulting in a loss of warranty coverage. Specifications and design are subject to change without notice.

Consult Your Local SCOTSMAN Representative At:

IMPORTANT OPERATING REQUIREMENTS:

	Minimum	Maximum
Air Temperatures	50°F (10°C)	100°F (37.7°C)
Water Temperatures	40°F (4.4°C)	100°F (37.7°C)
Remote Cond. Temps	-20°F (-28.9°C)	120°F (48.9°C)
Water Pressures	20 PSIG	120 PSIG
Electrical Voltage	-5%	+10%

YOU'LL VALUE THE DIFFERENCE™

775 Corporate Woods Parkway • Vernon Hills, IL 60061 • 1-800-SCOTSMAN • Fax: (847) 913-9844
Visit our website at: www.scotsman-ice.com • E-mail: customer.service@scotsman-ice.com